

YDT1318-66

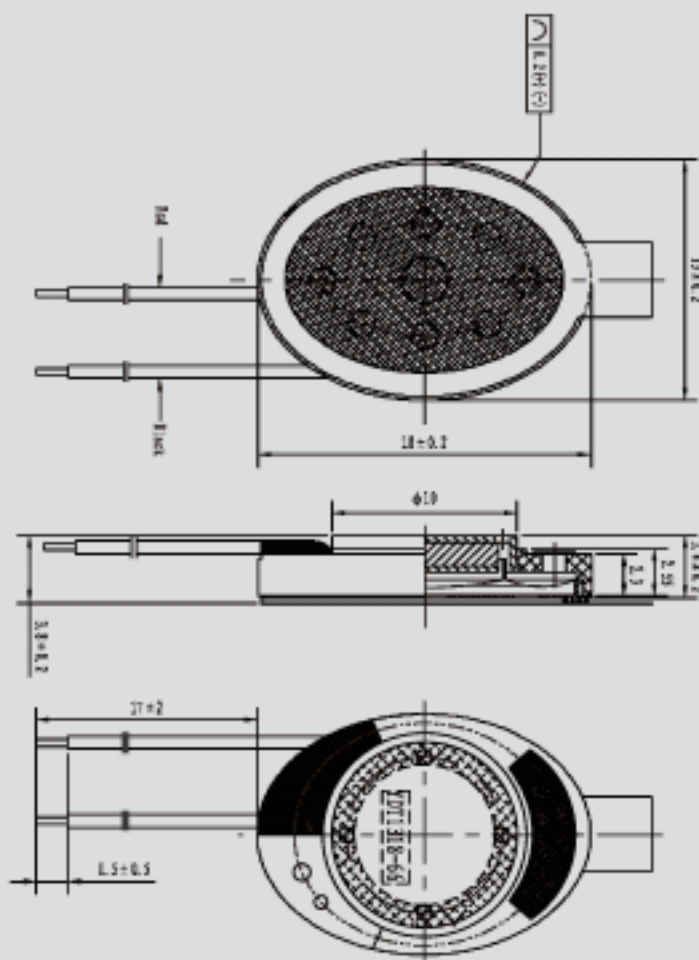

Rated input
 Max input
 Frequency range
 Resonance frequency
 Impedance@2KHz
 SPL@0.8, 1.0, 1.2, 1.5KHz
 (0.1W/0.1m)
 Frequency range
 Impedance@2KHz
 SPL@1 kHz(100mv)

0.5W
 1.0W
 $F_0 \sim 20\text{KHz}$
 $950 \pm 20\% \text{Hz}$
 $8 \pm 15\% \Omega$
 $90 \pm 3\text{dB}$
 $300 \sim 3400\text{Hz}$
 $8 \pm 15\% \Omega$
 $125 \pm 3\text{dB}$

